

HOME SLEEP TESTING DEVICE INSTRUCTIONS

If you have a Medical Emergency, call 911.

If you have technical questions during your test, please call Complete Sleep Solutions : (951) 698-6629.

If calling during regular business hours, ask for Home Sleep Study technical support.

NOTE : If there is no answer, the sleep technician may be with a patient. Please leave a voicemail.

Calls are typically returned within 20 minutes.

GETTING STARTED

There are four main steps to setting up and completing your Home Sleep Test (HST):

1. FITTING THE HST DEVICE
2. STARTING THE TEST
3. STOPPING THE TEST
4. DISASSEMBLING AND RETURNING THE HST DEVICE

Before fitting, set out all the system components and read these instructions first.

NOTE: Wear Apnea Link Air and belt over pajamas or nightshirts with long sleeves to avoid any discomfort from the belt.

Instructional video at <https://www.youtube.com/watch?v=awa4z2fn7A>

1. FITTING:

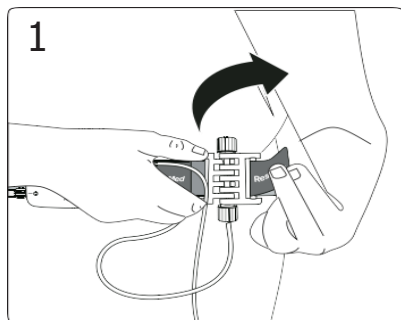

Pull the belt around your body. Thread the end of the belt through the slot on the effort sensor (if used) and fasten the tab to the belt. If you are not using the effort sensor, attach the tab to the belt.

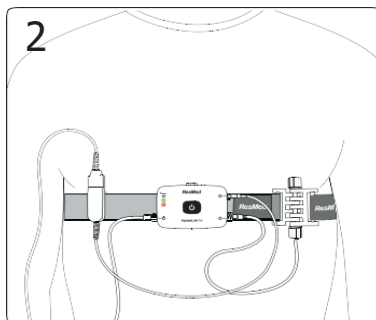

Check that the belt is secure and comfortable and that the device is positioned over the center of your chest.

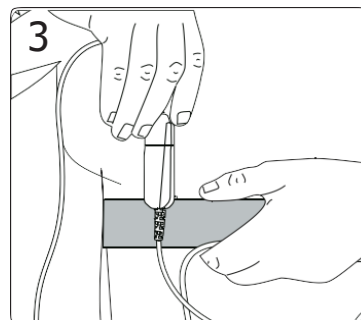

If using an oximeter, slide the clip onto the belt. The clip should be worn on the same side of your body as the oximeter finger.

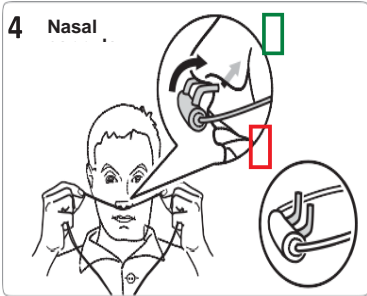

Fit the nasal pressure cannula so that the two small open tubes point towards your nostrils. When doing this, ensure that the ends point downwards.



Fit the loop around your ears and then back around your neck, without pulling over your head.



Draw the cannula to a comfortable position under your chin. If tape or adhesive pads have been provided, place them as indicated to help secure the cannula.

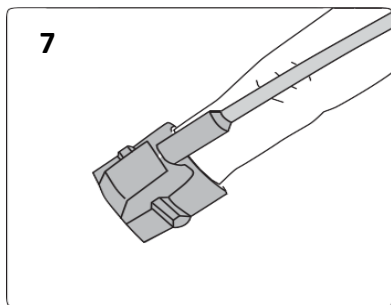

Reusable finger sensor

To fit the reusable finger sensor, slip it over the index finger on your non-dominant hand as shown. This will light up red and stay red throughout the study.

NOTE: If the finger sensor is uncomfortable, you can move it to a different finger or your other hand.

2. STARTING THE TEST

NOTE: Once you have started the test do not turn off until completed next morning.

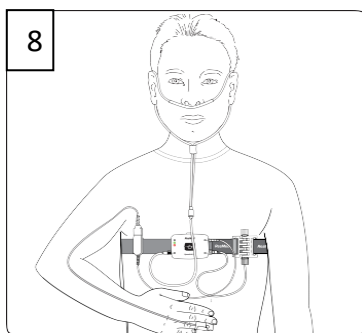

When properly set up, the full system looks like this.

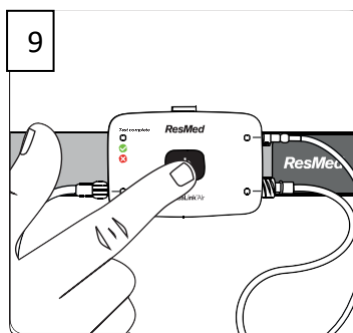

Press and hold the power button in the center of the device for about three seconds or until the light turns on.

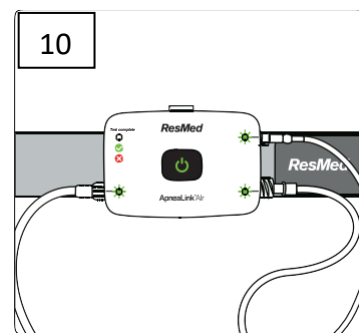

Check that lights next to the accessories you are using are green. If any of these lights are red and blinking, the accessories are not attached correctly. Remain still for a few moments until the system registers and turns green. They will blink red if you are moving around.

Once you have started the test, go to sleep as usual. The lights on the device will dim after 10 minutes. If you have to get up during the night for any reason, leave the device on unless you do not intend to go back to sleep. You can remove the oximeter finger sensor if you need to go to the bathroom or wash your hands. Replace the oximeter finger sensor before going back to sleep.

3. STOPPING THE TEST

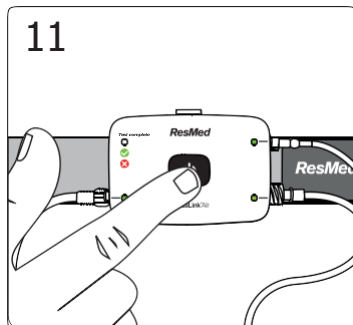

Press the power button for about three seconds.

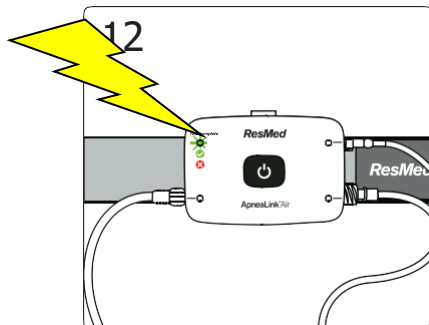

Check that the test complete. Indicator light is lit and green. This means the test is complete. If the test indicator light is red upon return of unit notify receptionist.

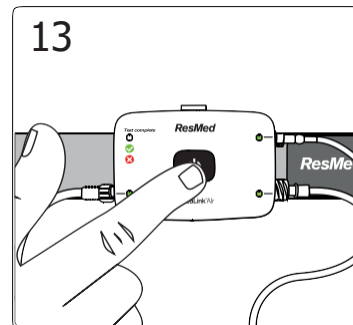

Press and hold the power button for about three seconds to turn off the device.

4. DISASSEMBLING AND RETURNING THE DEVICE

When the test is completed:

1. Remove the belt from your body.
2. Remove the finger sensory and nasal cannula
3. Place everything back in the box and return it to your physician or healthcare provider as requested.

NOTE: Do not attempt to clean the device.

If you have a Medical Emergency, call 911.

If you have technical questions during your test, please call Complete Sleep Solutions : (951) 698-6629,

If calling during regular business hours, ask for Home Sleep Study technical support.

NOTE : If there is no answer, the sleep technician may be with a patient. Please leave a voicemail.

Calls are typically returned within 20 minutes.



COMMONLY ASKED QUESTIONS

Why are the lights blinking red and how do I make them stop?

The sensors are very sensitive, easily detecting tense muscles that tend to be more prevalent when you are awake. Movement causes the indicator lights to blink red if they are not attached appropriately or you are moving around too much. When you are still and calm it should turn back to solid green.

The lights will dim in approximately 10 minutes so that they aren't visually disruptive during sleep.

I couldn't turn off the testing unit in the morning. Does this mean the data will be lost?

It's okay if you can't turn the unit off—this sometimes happens. Normally, you press and hold the center button for a few seconds to shut the unit off. The *test complete* light will light up and the indicators will stop flashing. If the unit does not shut off after you've repeated the shut-off process several times, you can just pack it up, let it continue to run and drop the unit off at our office.

The data collected during the night will *not* be affected and when we upload the study we will be able to tell where the study ended.

The *test complete* light was red (instead of green) in the morning when stopped I the test. Is that a problem?

Not necessarily. The unit's sensors are so sensitive that if they don't get continual input they can light up red instead of green when shut off. However, when we upload the results we can filter the input; most of the time the study will be fine. Bring the unit in and if you need to repeat the test we will contact you.

I accidentally turned the unit on when packing it up. What should I do?

Not to worry—accidentally turning it back on will not erase or affect any of the data from the night before. The data is actually not removed from the device until we upload it to our software. Simply shut the unit off again.

The unit was off when I woke up. Does this mean I have to repeat the study?

It depends on how much data was captured during the night. The center button is recessed on the unit so it won't easily get turned off with movement or when lying on the unit. If it was accidentally turned off, still pack it up and bring it to the office. We will upload the data and determine if there was enough recording time for a completed study. If the duration of the study is too short you will need to repeat the study, in which case we would contact you.